

# Development of Ammonia Gas Turbine Co-Generation Technology

**ITO Shintaro** : Doctor of Engineering, Combustion & Engine Group, Technology Platform Center, Technology & Intelligence Integration

**UCHIDA Masahiro** : Doctor of Engineering, Manager, Combustion & Engine Group, Technology Platform Center, Technology & Intelligence Integration

**SUDA Toshiyuki** : Doctor of Engineering, Manager, Business Development Department, Resources, Energy & Environment Business Area

**FUJIMORI Toshiro** : Doctor of Engineering, Technical advisor, Technology & Intelligence Integration

To develop an ammonia/natural gas co-fired gas turbine, there is a challenge in compliance with environmental regulations of NO<sub>x</sub> concentration in flue gas. To solve the challenge, power generation tests have been conducted using a 2 MW-class gas turbine with a low NO<sub>x</sub> combustor. Power generation of 2 MW and a reduction of CO<sub>2</sub> emissions with ammonia mixing ratio of 20% has been achieved. It has been confirmed that the NO<sub>x</sub> removal device can reduce NO<sub>x</sub> concentration below 7 ppm. The performance calculation of the heat recovery steam boiler using the measured data as an input value has also been performed. The result showed that the total efficiency of ammonia/natural gas co-fired gas turbine co-generation system can be kept at the same level as a natural gas fired system.

## 1. Introduction

In Japan and overseas, hydrogen is attracting attention as an alternative fuel for reducing CO<sub>2</sub> emissions resulting from the use of fossil fuels. Hydrogen can be produced by renewable energy sources, and no CO<sub>2</sub> is produced when hydrogen burns. However, it is costly to transport and store hydrogen as a gas. As a solution to this problem, increasing attention is being given to methods in which hydrogen is transported after liquification or conversion to chemical substances suitable for transportation and storage, such as methylcyclohexane (MCH) or ammonia<sup>(1)</sup>. Among these chemical substances, ammonia has the following excellent characteristics:

- (1) The hydrogen content per unit volume is high.
- (2) The saturation vapor pressure at 20°C is approximately 9 times atmospheric pressure, and so ammonia can easily be liquified and is suitable for transportation and storage.
- (3) Ammonia is used widely in fertilizers, as a chemical raw material, and as a reducing agent for the removal of NO<sub>x</sub> in thermal power plants; therefore, there exist well-developed production, transportation, and storage technologies and infrastructure.
- (4) Ammonia can be burned without being reconverted to hydrogen.

It is expected that power generation equipment such as gas turbines, boilers, and fuel cells will use ammonia. Among these, it is anticipated that gas turbines will be utilized as a power source for regulating load fluctuations when renewable energy sources, such as photovoltaics and wind power generation, are used<sup>(2)</sup>. Therefore, it is believed that the use of ammonia as a fuel for gas turbines will contribute greatly to the achievement of a sustainable society.

Ammonia has combustion characteristics quite different to natural gas, which is widely used as a fuel for gas turbines. Ammonia burns at a rate approximately one-fifth that of natural gas, generates around half as much heat, and has an adiabatic flame temperature that is around 150°C lower<sup>(3)</sup>. Gas turbine combustors have an extremely small cross-sectional area and volume, and so the gas flows at a high velocity and resides in the combustor for only a short time. If ammonia is burned in such a combustor, there is a risk of blow-off and/or unburned ammonia being discharged. In addition, gas turbines for power generation are subject to regulations regarding the concentration of nitrogen oxide (NO<sub>x</sub>) contained in the flue gas. When natural gas is burned, NO<sub>x</sub> is generated mainly by oxidation of nitrogen in the atmosphere at the high temperatures produced by combustion. However, when ammonia is burned, NO<sub>x</sub> is generated mainly by oxidization of nitrogen atoms contained in ammonia molecules<sup>(4)</sup>. For this reason, when ammonia is used as a gas turbine fuel, it is difficult to use a combustor developed for natural gas without modification. Therefore, there is a need to establish a combustion technology that is suited to burning ammonia and limits emissions of unburned NH<sub>3</sub>, NO<sub>x</sub>, etc. to low levels.

Up to the present, IHI has been working to develop a low emission combustor for ammonia/natural gas co-firing with the aim of establishing a combustion technology that meets environmental regulations when ammonia and natural gas are co-fired at an ammonia mixing ratio of 20% using 2 MW-class gas turbines<sup>(5)</sup>, <sup>(6)</sup>. This paper describes the results of a rig test conducted during combustor development, and of a power generation test conducted using a 2 MW-class gas turbine.

## 2. Development of a low NO<sub>x</sub> emission combustor for ammonia/natural gas co-firing

### 2.1 Structure of the combustor

In order to limit NO<sub>x</sub> emissions, which is the biggest issue with respect to burning ammonia, IHI developed a combustor that is suitable for ammonia co-firing. On the assumption of ammonia being co-fired with natural gas, the combustor was developed based on a low NO<sub>x</sub> combustor for burning natural gas only. **Figure 1** is a schematic diagram of the ammonia/natural gas co-firing combustor that was developed. The burner in the upper part of the figure (enclosed in a green box) is a lean premixed burner that burns the fuel after premixing it with air under conditions that are leaner than stoichiometric conditions. This burner has a coaxial tube structure consisting of internal burner 1 and external burner 2. These burners have corresponding fuel injection nozzles 1 and 2, from which natural gas and ammonia can be injected. Furthermore, in order to achieve low NO<sub>x</sub> combustion when co-firing ammonia in this combustor, fuel injection nozzle 3 is positioned in the liner downstream of the burner. Part of the combustion air is supplied to the interior of the combustor through dilution holes in the liner, but the combustor is designed such that these holes are located downstream of fuel injection nozzle 3.

### 2.2 Effect of ammonia injection position on emissions

Performance evaluation and design improvement were carried out using an atmospheric pressure combustion test rig. As an example of the rig test results, **Fig. 2** shows the relationship between ammonia injection position and emissions. In this test, with the flow rates of air, natural gas, and ammonia supplied throughout the combustor kept constant and only the distribution of ammonia supplied to fuel injection nozzles 2 and 3 being changed, the corresponding effect on emissions was evaluated. The horizontal axis

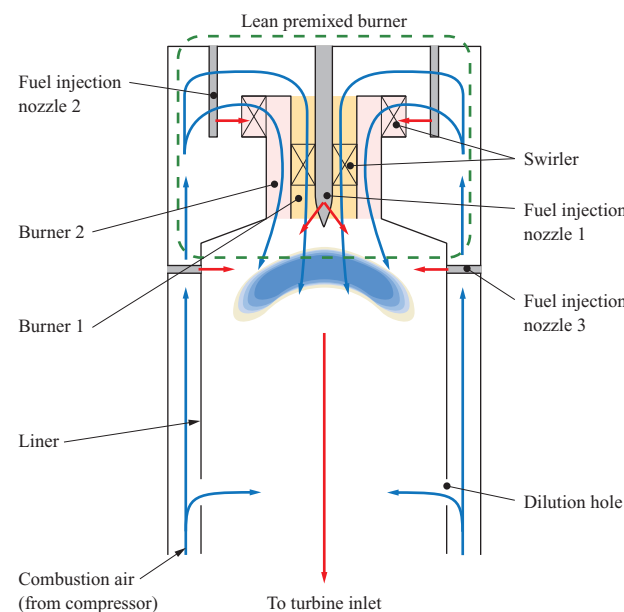

**Fig. 1** Schematic of ammonia/natural gas co-fired combustor

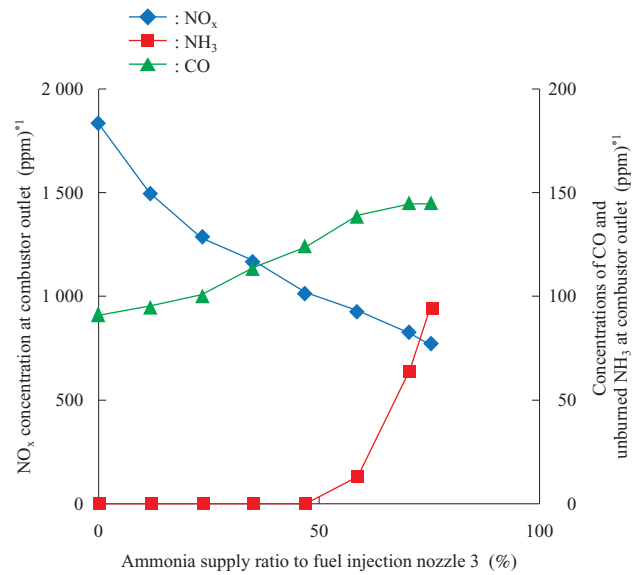

(Note) \*1 : Converted to oxygen concentration of 16%

**Fig. 2** Effect of ammonia supply ratio to fuel injection nozzle 3 on NO<sub>x</sub>, unburned NH<sub>3</sub> and CO concentration at combustor outlet

represents the ratio of ammonia supplied to fuel injection nozzle 3 with respect to the total amount of ammonia supply, and the vertical axis represents the concentrations of NO<sub>x</sub>, CO, and unburned NH<sub>3</sub> — calculated as dry concentrations that exclude water vapor concentration — converted to an oxygen concentration of 16%. It can be seen that as the amount of ammonia supplied to fuel injection nozzle 3 increases, the CO and unburned NH<sub>3</sub> concentrations increase but the NO<sub>x</sub> concentration decreases.

In order to explain such flame behavior, an investigation based on the reaction paths of ammonia was performed using numerical calculations. **Figure 3** shows the main ammonia reaction paths for ammonia/methane/air combustion. The

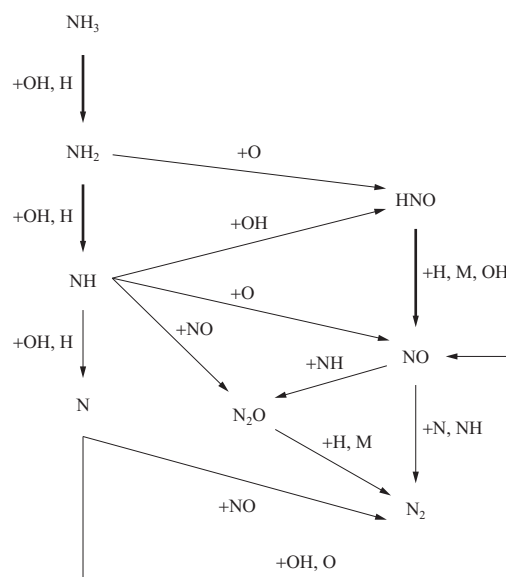

**Fig. 3** Reaction path of ammonia in ammonia/methane/air combustion

calculation was performed with an ammonia mixing ratio of 20%LHV (mixing ratio of 20% based on lower heating value), which was the same as in the test, and stoichiometric conditions were used for the fuel-air mixture. The detailed reaction mechanism of Okafor et al.<sup>(7)</sup> was used as the reaction mechanism of the calculation. In order for NH<sub>3</sub> to react during the process of combustion, OH and O radicals, which are produced by the reaction of oxygen, are required as reactants. Furthermore, OH and O radicals are also required for the NO formation reaction. Here, when oxygen concentration in the region of combustion is low, the production of OH and O radicals is limited due to lack of oxygen, and so the production of NO may be limited. At the same time, unburned NH<sub>3</sub>, and NH<sub>2</sub>, NH, and N radicals will tend to remain. Conversely, NH and N radicals are required as reactants in the reaction by which NO is reduced to produce N<sub>2</sub>. From a comparison between this reaction mechanism and the combustion test results, the following reaction behavior is considered to occur when ammonia is injected from fuel injection nozzle 3. The ammonia injected from nozzle 3 burns in a region where the oxygen concentration has decreased due to combustion of natural gas, and so, compared to injection from nozzle 2, the ammonia burns under conditions in which the surrounding OH and O radical concentrations are lower. Therefore, the concentrations of unburned NH<sub>3</sub>, and NH<sub>2</sub> and NH radicals increase. It is believed that these effects limit production of NO and also promote reduction of NO, thereby decreasing NO emissions.

Using fuel injection nozzle 3 in this way is effective for reducing NO<sub>x</sub> emissions during ammonia combustion, and it was therefore decided to inject all the ammonia from this nozzle. However, since an increase in unburned NH<sub>3</sub> concentration may pose a problem for operation of gas turbines, we worked to develop a combustor that further

reduces NO<sub>x</sub> concentration and simultaneously reduces unburned NH<sub>3</sub> concentration. As a result of optimizing design parameters, such as the location and shape of fuel injection nozzle 3 and the ammonia injection method, we have successfully reduced NO<sub>x</sub> concentration to approximately one-fifth of that at the early stage of development, and have reduced unburned NH<sub>3</sub> concentration to 1 ppm or less.

### 3. Power generation test facility and test method

#### 3.1 Power generation test facility

Figure 4 shows a system flow diagram of the power generation test facility. The main constituents of the facility are an ammonia supply unit, natural gas compressor, gas turbine, and NO<sub>x</sub> removal unit. The facility was installed in the IHI Yokohama Works, and a power generation test performed. Figure 5 shows the ammonia supply unit, and Table 1 shows its specifications.

This ammonia supply unit consists of two ammonia supply systems: one is for supplying ammonia gas at a high pressure of 2.0 MPaG as fuel, and the other is for supplying it at a low pressure of 0.3 MPaG as a reducing agent to the NO<sub>x</sub> removal unit. Ammonia is stored as liquid in a tank and supplied to each system as liquid. The fuel ammonia supply system uses a pump to compress the liquid ammonia. By compressing ammonia in its liquid state, the compression power and installation area of the pump can be reduced to less than that required for compression after gasification. The compressed liquid ammonia is gasified with a hot-water-type evaporator and supplied to the gas turbine after pressure fluctuations have been suppressed by an accumulator. In order to prevent ammonia from re-condensing in the high-pressure ammonia gas supply piping, the piping and accumulator are heated by electric heaters so that their temperatures are sufficiently higher than the condensation temperature of ammonia.

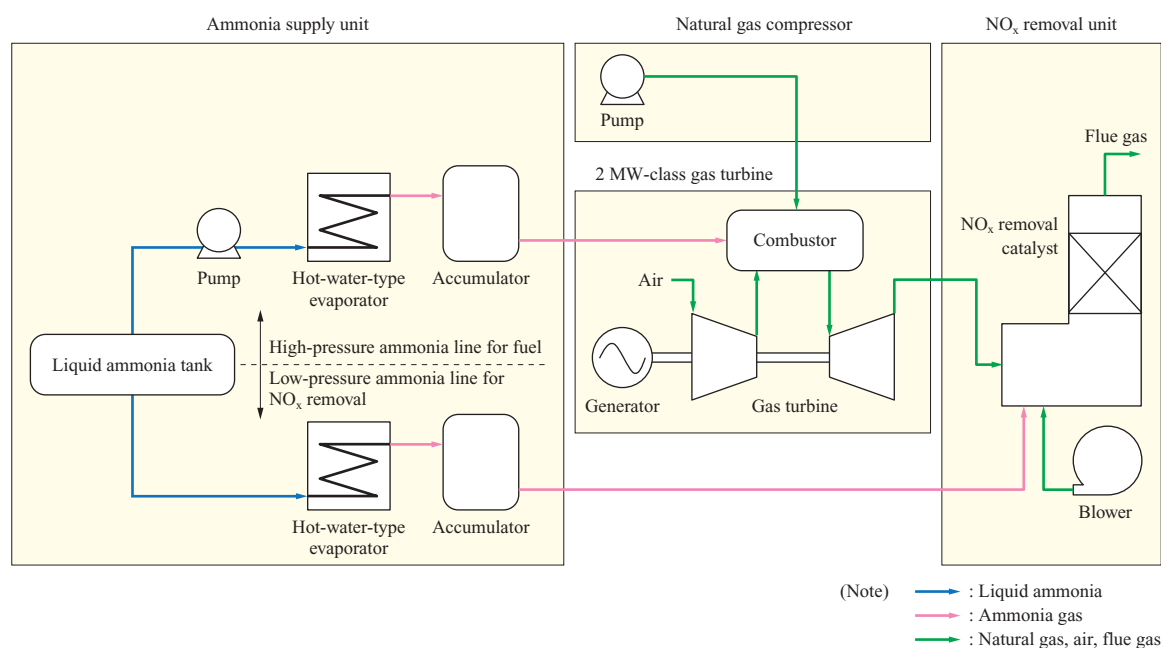

Fig. 4 System flow diagram

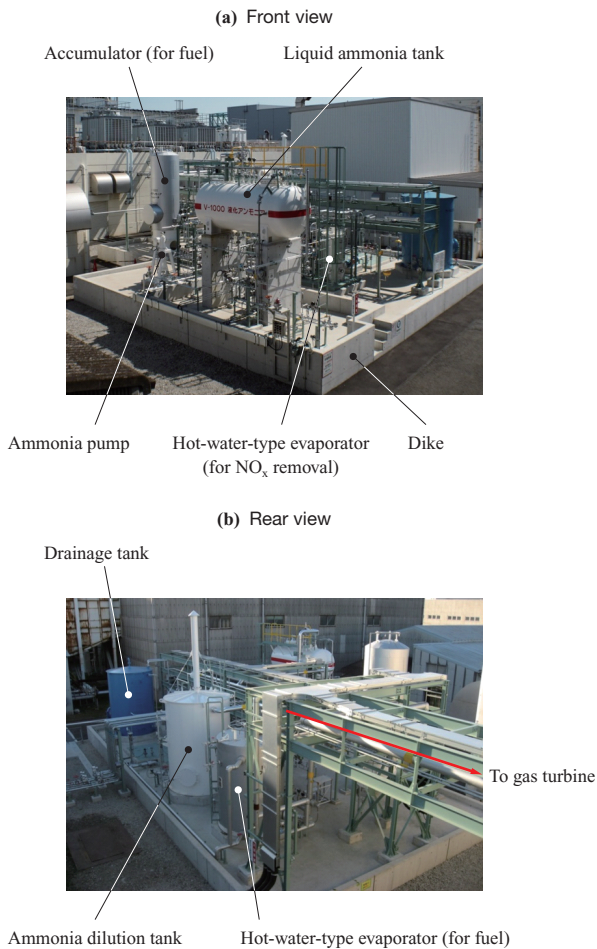

Fig. 5 Apparatus of ammonia supply unit

Table 1 Spec of ammonia supply unit

Item	Unit	For fuel	For NO <sub>x</sub> removal
Liquid ammonia tank capacity	t		4.5
Maximum supply pressure	MPaG	2.0	0.3
Ammonia gas temperature	°C	70	Ambient temperature
Maximum supply flow rate	kg/h	400	60

However, the pressure needed to supply ammonia to the NO<sub>x</sub> removal unit is lower than the storage pressure of the liquid ammonia tank. Therefore, the ammonia for NO<sub>x</sub> removal is supplied to the NO<sub>x</sub> removal unit after decompression by a pressure control valve installed downstream of the evaporator.

Figure 6 shows the gas turbine unit. The gas turbine used is an IM270, which is a 2 MW-class simple-cycle gas turbine manufactured by IHI. In this facility, the waste heat recovery boiler downstream of the gas turbine is omitted, and the turbine outlet is connected directly to the NO<sub>x</sub> removal unit. Thus, the gas turbine unit as used here consists of standard components used for natural gas combustion with the only exception that standard combustor and boiler are replaced with the low NO<sub>x</sub> emission combustor for ammonia/natural gas co-firing described in Chapter 2.

The NO<sub>x</sub> removal unit is of the SCR (selective catalytic reduction) type, and ammonia gas is used as a reducing agent. The catalyst used is one that is commonly employed in

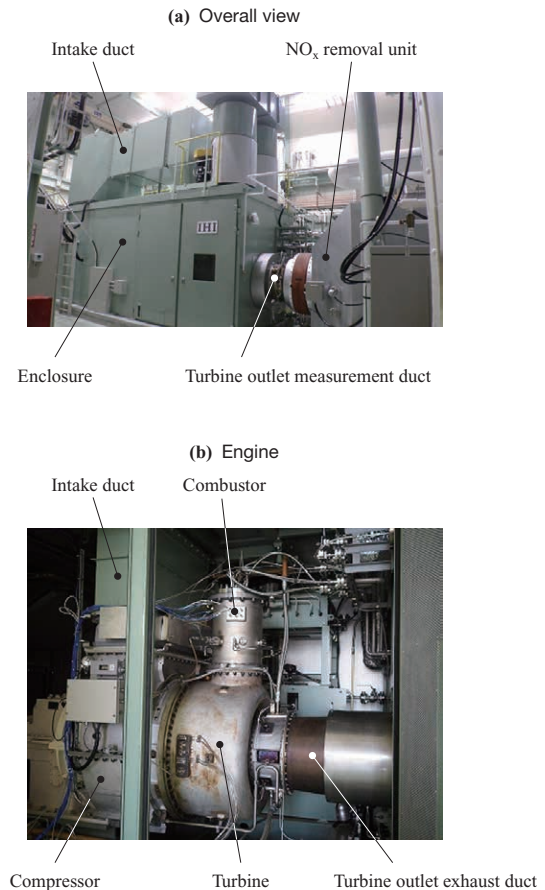

Fig. 6 Apparatus of gas turbine

natural gas-fired gas turbines.

### 3.2 Methods for operating, testing, and measuring the gas turbine

At the beginning of operation, i.e. from starting the gas turbine up to the power output reaching 2 MW, only natural gas was used, after which fuel ammonia was supplied. The control system was designed to automatically adjust natural gas flow rate in accordance with ammonia flow rate so that turbine speed and power output were kept constant. In the test, the ammonia mixing ratio was changed from 0 to 20%LHV, and the performance was measured.

Flue gas measurement was performed at the turbine outlet and NO<sub>x</sub> removal unit outlet in order to evaluate the performance of the low NO<sub>x</sub> emission combustor. At the turbine outlet, a gas sampling probe and thermocouple were installed to allow measurement of emissions and gas temperature. Gas analysis was performed using gas analyzers (MEXA-ONE-D1 and VA-3001, manufactured by HORIBA, Ltd.) in order to measure the concentrations of six components: CO, CO<sub>2</sub>, O<sub>2</sub>, THC (total hydrocarbon, CH<sub>4</sub> equivalent), NO<sub>x</sub>, and NH<sub>3</sub>. A sampling probe was also installed at the outlet of the NO<sub>x</sub> removal unit to measure the concentrations of O<sub>2</sub>, NO<sub>x</sub>, and NH<sub>3</sub> using a gas analyzer (ENDA-C9430A, manufactured by HORIBA, Ltd.). Emissions were evaluated according to the method specified by the Air Pollution Control Act, which was enacted by the Japanese Ministry of the Environment, using dry concentrations, i.e.

excluding water vapor concentration, and converted to an oxygen concentration of 16%.

#### 4. Results of engine test and examination of total efficiency

##### 4.1 Results of engine test

Figure 7 shows the change in power output and natural gas supply flow rate against changing ammonia mixing ratio. Even when the ammonia mixing ratio is changed, it was confirmed that the gas turbine can operate stably, without problems such as abnormal noise, vibration, or temperature in the combustor or engine. The natural gas supply flow rate with an ammonia mixing ratio of 20%LHV is approximately 23% lower than that when only natural gas is burned, confirming that the CO<sub>2</sub> emission reduction rate is greater than the ammonia mixing ratio. This is because the lower heating value of ammonia is half that of natural gas, and the gas flow through the turbine increases when ammonia co-firing is performed. Due to the effect of this increase in gas flow, gross thermal efficiency increases, and the CO<sub>2</sub> emission reduction rate increases. This effect has also been confirmed in cycle simulations<sup>(8)</sup>.

Figure 8 shows the change in NO<sub>x</sub> concentration at the turbine outlet and NO<sub>x</sub> removal unit outlet with respect to the ammonia mixing ratio. The NO<sub>x</sub> concentration at the turbine outlet increases rapidly as the ammonia mixing ratio increases from 0%LHV to 5%LHV but changes little when the ratio exceeds 5%LHV. When the ammonia mixing ratio is 20%LHV, the NO<sub>x</sub> concentration at the turbine outlet is approximately 290 ppm (converted to an oxygen concentration of 16%). In contrast, the NO<sub>x</sub> concentration at the NO<sub>x</sub> removal unit outlet is at most 6.1 ppm (converted to an oxygen concentration of 16%), which satisfies the gas turbine environmental regulation value of 7 ppm (converted to an oxygen concentration of 16%) specified in Yokohama City, where this facility was installed. From the above, it was confirmed that the NO<sub>x</sub> concentration at the turbine outlet during ammonia/natural gas co-firing is higher than that in

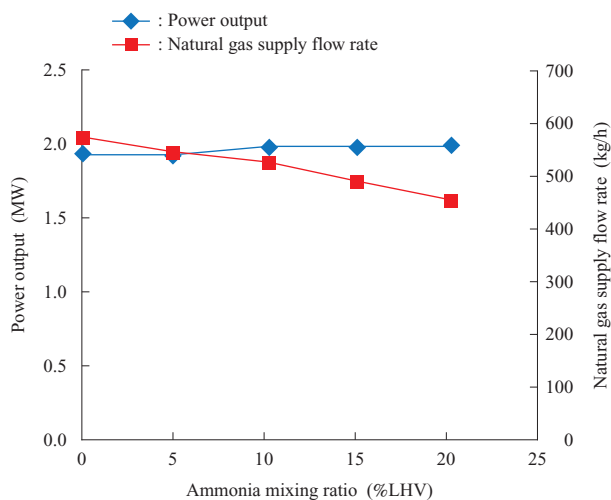
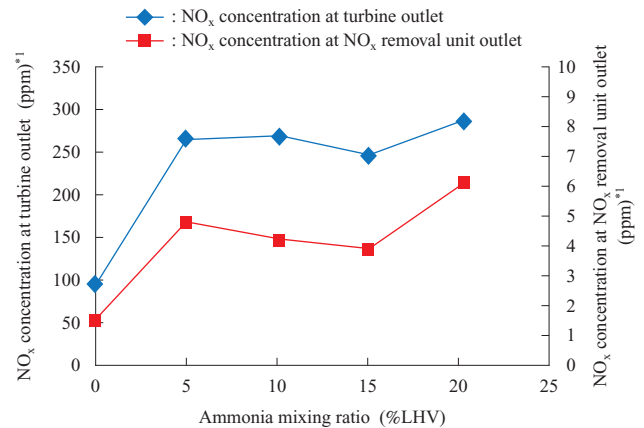

Fig. 7 Effect of ammonia mixing ratio on generator output and natural gas supply rate



(Note) \*1 : Converted to oxygen concentration of 16%

Fig. 8 Effect of ammonia mixing ratio on NO<sub>x</sub> concentration at turbine outlet and SCR unit outlet

general natural gas-fired gas turbines but can be reduced to a practical level using a NO<sub>x</sub> removal unit. The concentrations of unburned NH<sub>3</sub>, CO, and THC at the turbine outlet are all 3 ppm or less (converted to an oxygen concentration of 16%). Hence, it was confirmed that ammonia and natural gas were almost completely burned, and that the combustor which was developed is effective for burning ammonia stably with low NO<sub>x</sub> emissions.

##### 4.2 Examination of total efficiency

Since this facility omits a waste heat recovery boiler, the total efficiency of the system when using a boiler was examined through a model calculation. Here, total efficiency is the sum of the gross thermal efficiency and thermal efficiency of the waste heat recovery boiler. The results of the power generation test were used for the gross thermal efficiency, and the thermal efficiency of the waste heat recovery boiler was evaluated by a model calculation that took account of the flow rate, composition, and temperature change of the flue gas. The specifications adopted for the waste heat recovery boiler were those of a natural-circulation-type water pipe boiler that is commonly used in the co-generation system of an IM270 gas turbine, and a calculation model was constructed using heat balance calculation software. In the calculation, the results obtained from the power generation test were used as the input values for the flow rate, composition, and temperature of the flue gas. From the test results, it was confirmed that the turbine outlet gas temperature for ammonia co-firing differs by only a few degrees Celsius from that for natural gas firing when the ammonia mixing ratio is 20%LHV or less, and so ammonia co-firing has little effect on turbine outlet temperature.

Figure 9 shows the change in total efficiency against changing ammonia mixing ratio. Up to an ammonia mixing ratio of 20%LHV, the total efficiency is 80% or more, which is almost the same as that for natural gas firing. One of the reasons this result was obtained is that the concentration of unburned components during ammonia co-firing was suppressed, and so the decrease in gross thermal efficiency could be limited; hence, it was confirmed that the combustor

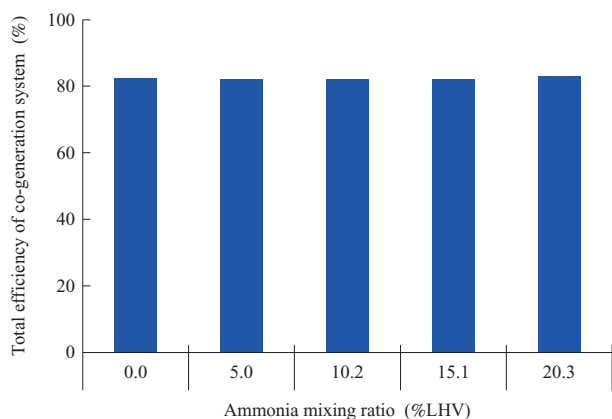

Fig. 9 Effect of ammonia mixing ratio on total efficiency

which was developed is also useful from the viewpoint of total efficiency.

## 5. Conclusion

In order to use ammonia as a gas turbine fuel, we developed a low  $\text{NO}_x$  emission combustor for ammonia/natural gas co-firing, and conducted a power generation test using a 2 MW-class gas turbine. For development of the combustor, ammonia injection nozzles were adopted and the design parameters optimized, allowing successful simultaneous reduction of both  $\text{NO}_x$  and unburned  $\text{NH}_3$ . As the result of a power generation test conducted with this combustor mounted on a 2 MW-class gas turbine, it was demonstrated that the gas turbine can operate stably with a power output of 2 MW and ammonia mixing ratio of 20%LHV, and the following was confirmed:

- (1) The adoption of the low  $\text{NO}_x$  combustor enables compliance with environmental regulations regarding  $\text{NO}_x$  concentration when used with a  $\text{NO}_x$  removal unit commonly employed in natural gas-fired plants.
- (2) Since the heating value per unit volume of ammonia is smaller than that of natural gas, ammonia co-firing increases gross thermal efficiency. For this reason, the  $\text{CO}_2$  emission reduction rate for ammonia co-firing is greater than the ammonia mixing ratio.
- (3) Since the low  $\text{NO}_x$  combustor limits the emission of unburned components, the total efficiency of the co-generation system during ammonia co-firing can be maintained at the same level as that during natural gas firing.

In this way, although ammonia co-firing requires an ammonia supply system, the gas turbine itself can be adapted by retrofitting, with only the combustor being replaced. In addition, since the total efficiency of the engine can be maintained, it was confirmed that ammonia co-firing is effective for reducing  $\text{CO}_2$  emissions. However, the  $\text{NO}_x$  concentration at the turbine outlet during ammonia co-firing is still higher than that during natural gas firing, and so

further reduction of the  $\text{NO}_x$  concentration will contribute to reducing the initial and running costs of the plant. Going forward, we intend to continue improving the combustor in order to further reduce  $\text{NO}_x$  emissions. In addition, in order to further reduce  $\text{CO}_2$  emissions from the gas turbine, we will continue our research regarding operation of the gas turbine at higher ammonia mixing ratios.

### — Acknowledgments —

This study was conducted as part of the Council for Science, Technology and Innovation's Cross-ministerial Strategic Innovation Promotion Program (SIP) "Energy Carriers" (administered by the Japan Science and Technology Agency (JST)). We would like to express our gratitude to all relevant parties.

## REFERENCES

- (1) B. Shiozawa : Energy carriers for developing hydrogen energy based society (1), International Environment and Economy Institute < <http://ieei.or.jp/2014/09/expl140916/> >, accessed 2019-09-05
- (2) International Renewable Energy Agency : Perspectives for the energy transition : Investment needs for a low-carbon energy system, < [https://www.irena.org/-/media/Files/IRENA/Agency/Publication/2017/Mar/Perspectives\\_for\\_the\\_Energy\\_Transition\\_2017.pdf](https://www.irena.org/-/media/Files/IRENA/Agency/Publication/2017/Mar/Perspectives_for_the_Energy_Transition_2017.pdf) >, accessed 2019-09-05
- (3) H. Kobayashi, A. Hayakawa, K. D. K. A. Somaratne and E. C. Okafor : Science and technology of ammonia combustion, Proceedings of the Combustion Institute, Vol. 37, Iss. 1, 2019, pp. 109-133
- (4) J. A. Miller, M. D. Smooke, R. M. Green and R. J. Kee : Kinetic Modeling of the Oxidation of Ammonia in Flames, Combustion Science and Technology, Vol. 34, Iss. 1-6, 1983, pp. 149-176
- (5) S. Ito : Research on Ammonia/Natural Gas Co-fired Gas Turbine Combustor, JSME Thermal Engineering Division Newsletter, No. 87, 2019, pp. 3-8
- (6) S. Ito, M. Uchida, T. Fujimori and H. Kobayashi : A Study of Low  $\text{NO}_x$  Combustion Method for Ammonia/Natural Gas Co-fired Gas Turbine Using Detailed Chemistry, Journal of the Combustion Society of Japan, Vol. 61, No. 198, 2019, pp. 368-375
- (7) E. C. Okafor, Y. Naito, S. Colson, A. Ichikawa, T. Kudo, A. Hayakawa and H. Kobayashi : Experimental and numerical study of the laminar burning velocity of  $\text{CH}_4\text{-NH}_3\text{-air}$  premixed flames, Combustion and Flame, Vol. 187, 2018, pp. 185-198
- (8) S. Ito, M. Uchida, T. Fujimori and H. Kobayashi : Performance Prediction by Cycle Simulation for Ammonia/Natural Gas Co-fired Gas Turbine, Vol. 48, No. 1, Journal of the Gas Turbine Society of Japan, 2020, pp. 58-65