

Development of Simple and High-Performance Technology for Aircraft Engine Fans

MIZUTA Ikuhisa : Manager, Advanced Technology Department, Research & Engineering Division, Aero-Engine & Space Operations
MUROOKA Takeshi : Engine Technology Department, Research & Engineering Division, Aero-Engine & Space Operations
GOTO Shinya : Turbo Machinery Department, Products Development Center, Corporate Research & Development
KODAMA Hidekazu : Doctor of Engineering, Technical Advisor, Aero-Engine & Space Operations

To reduce the direct operating cost of environmentally compatible engines for small aircraft, a new concept of aerodynamic design technology “Zero Hub to Tip Ratio Fan (ZH fan)” was developed, which is expected to increase the mass flow rate at the fan inlet without increasing the case diameter and to increase the fan’s inner total pressure ratio. Three dimensional aerodynamic design was conducted using Computational Fluid Dynamics, and each target for flow rate, efficiency, and pressure ratio was achieved in performance rig tests.

1. Introduction

The goal of environmentally compatible engine for small aircraft (ECO engine) is a drastic reduction in direct flight costs, which are comprised of acquisition, maintenance, and fuel costs. The fan, which has an outer diameter that is larger than that of any other element, takes up the largest portion of the engine in weight. Thus, simple, high-performance design technology is required to realize a substantial reduction in weight and lower costs by reducing the stage number of the low-pressure compressor and the number of parts, as well as by increasing the high flow rate and making the fan diameter smaller while maintaining high efficiency. To meet these requirements, it is necessary to apply new technology with a new concept added to fan design technology based on conventional design technology. The new concept called the “Zero Hub to Tip Ratio Fan” (hereinafter called the ZH fan) has been devised.

In this document the simple, high-performance fan technology is outlined, to which the new concept developed in the ECO engine project has been applied.

2. Target specifications for fans and concept of the ZH fan

As a result of the review on the engine’s basic cycle conducted for the realization of the direct flight costs reduction target, it has been learned that both an increase in flow rate and higher efficiency are necessary for the fans in existing engines. The trend chart on the

fan inlet corrected specific flow rate and efficiency in **Fig. 1** demonstrates the target performance of the increase in flow rate and higher efficiency. In addition, the achievement of a pressure ratio at the hub (core side of the engine) of 1.6 with a single stage was needed in order to reduce the number of stages in the low pressure compressor or eliminate it completely, so the target pressure ratio at the hub was set at 1.6 or over.

The concept of the ZH fan as shown in **Fig. 2** has been devised in order to achieve an increase in flow rate,

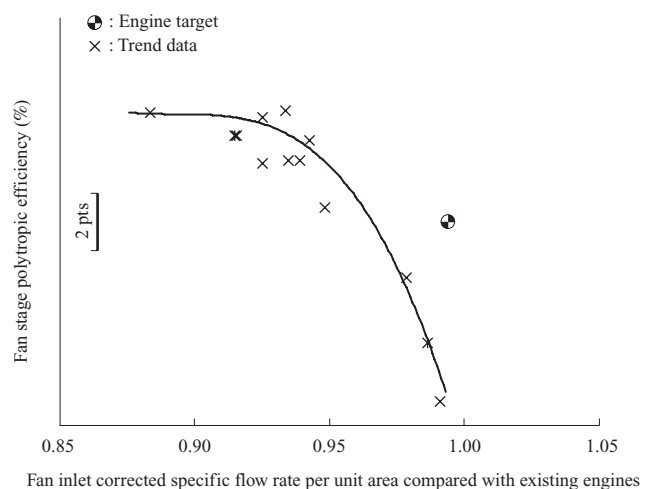

Fig. 1 High specific flow rate and efficiency targets of zero hub to tip ratio fans

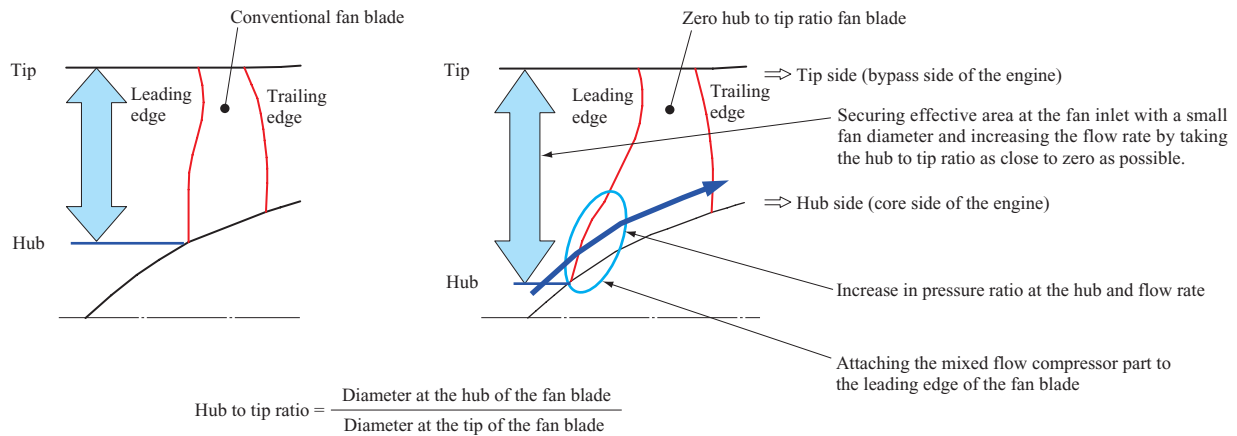

Fig. 2 Concept of the zero hub to tip ratio fan

higher efficiency, and higher pressure ratio at the hub.

- (1) It is possible to increase the pressure ratio at the hub using the centrifugal effect caused by extending the leading edge of the fan rotor blade's inner diameter to the upper stream.
- (2) It is possible to realize an increase in flow rate and higher efficiency by achieving a higher pressure ratio at the hub and an increase in effective area at the fan rotor inlet.

When it comes to the aerodynamic design of the ZH fan, it is necessary to control shock waves due to the flow accompanying it at the tip, whereas it is necessary to control the secondary flow due to the three-dimensional flow at the hub. This is why we need aerodynamic design technology that uses CFD (Computational Fluid Dynamics) analysis. The fan part requires a design which also takes into consideration the following: anti-FOD (Foreign Object Damage), the strength to withstand the engine sucking in a bird or a piece of ice, the toughness to prevent or withstand flutter (self-induced vibration in the blade attributed to aerodynamic activation), the strength handle the

distortion of air generated at the engine inlet by crosswinds, and the reduction of fan noise. Thus, in this research the design of the ZH fan is being carried out in conjunction with the study of the engine system, structure, noise, and so forth, and what is learned is reflected in the aerodynamic design.

In our research, a ZH fan test vehicle was designed and manufactured, and performance tests were implemented to substantiate the aerodynamic design technology developed with the use of CFD.

3. Design of the ZH fan

3.1 Configuration of the ZH fan blade

There were two different configurations designed and tested in carrying out the design of the ZH fan: the separate blade configuration and the single blade configuration as shown in Fig. 3. Characteristics of the separate blade configuration and single blade configuration are as follows:

- (1) Separate blade configuration

Since an engine is mounted on an aircraft in such a way that the fan blades are in a dovetail

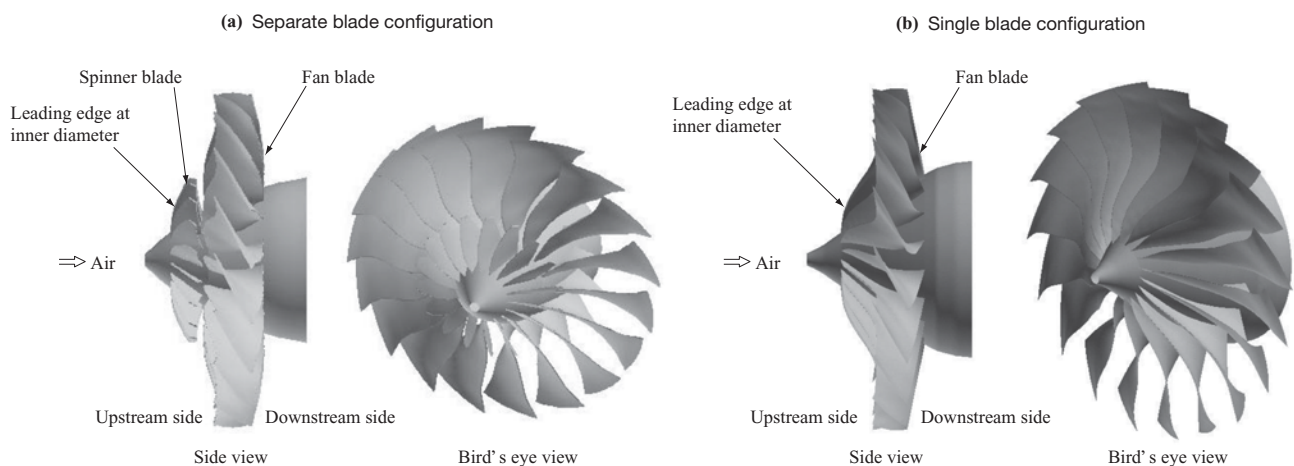

Fig. 3 Configurations of zero hub to tip ratio fan blade

configuration (in which the blades are inserted into a disk) and the spinner blade is in a blisk configuration (in which the disk and blades are unified), the separate configuration excels in light of maintenance such as the repair and exchange of fan blades. On the other hand, since a gap is structurally created at the separated portion, interference of the fan blade with the vortex and wake (portion of defective velocity generated at the trailing edge of a spinner blade) at the top of a spinner blade is generated, and flow leaking through the gap takes place. Therefore, this configuration is regarded as disadvantageous from the standpoint of aero-performance ; CFD analysis of the complex configuration is required.

(2) Single blade configuration

Improvement in aero-performance is expected compared to the separate blade configuration in that the spinner and fan blade portions are not separated. In light of the structural viability, however, the hub radius at the leading edge of a blade is smaller than existing engines, so a dovetail configuration as adopted by existing engines would lack structural strength. Therefore, the important point is the structure of the single blade.

Although the development of two configurations was carried out, the separate blade configuration, even though it has a disadvantage from an aerodynamic point of view, took precedence over the other, followed by the validation of the aerodynamic potential of the ZH fan and CFD application method for a complex configuration.

The target aero-performance for the separate blade configuration is set differently from that for the single blade configuration. The separate blade configuration is set so that more of an increase in flow rate and efficiency than the engine target level can be realized, whereas the single blade configuration is set so that

the desired increase in flow rate and efficiency at the engine target level is realized and higher efficiency within a low flow rating (a low rotational speed rating) is achieved at the same time. These targets are set with the engine operation taken into consideration for both configurations.

3.2 Aerodynamic design

Increasing pressure from the spinner portion makes a higher pressure ratio at the hub viable due to the formation of blades from the spinner portion at the ZH fan blade. In addition, the ZH fan blade was designed so that still higher efficiency could be achieved by adopting the sweep configuration, reducing pressure loss caused by shock waves at the blade tip following an increase in flow rate at the tip. **Figure 4** shows one of the results of the CFD analysis on a design point over the separate blade configuration of the ZH fan blade. The design process was carried out so that: interference from the wake generated at a spinner blade with a fan blade could be controlled in consideration of vortex restraint caused by the top of the spinner blade at the hub and deformation of a blade at the time of the revolution of a spinner blade, through the CFD application as shown in **Fig. 4**. Also, the design was implemented so that the inlet mach number at the tip in the transonic region (region where the mach number is equal to or more than one) contributes to creating an oblique shock wave and weakening the strength of the shock wave.

Since it is of utmost importance for the original concept of the ZH fan blade to be structurally viable, prediction by blade deformation analysis at the time of a bird colliding with a fan blade is conducted using the bird collision analysis technology shown in **Fig. 5**, and a bird wing-shaped fan blade with high stiffness for a bird strike is reflected in the concept.

The result of the research of the simple low noise technology is reflected by the integrated OGV (Outlet Guide Vane). Since a vane configuration, to which

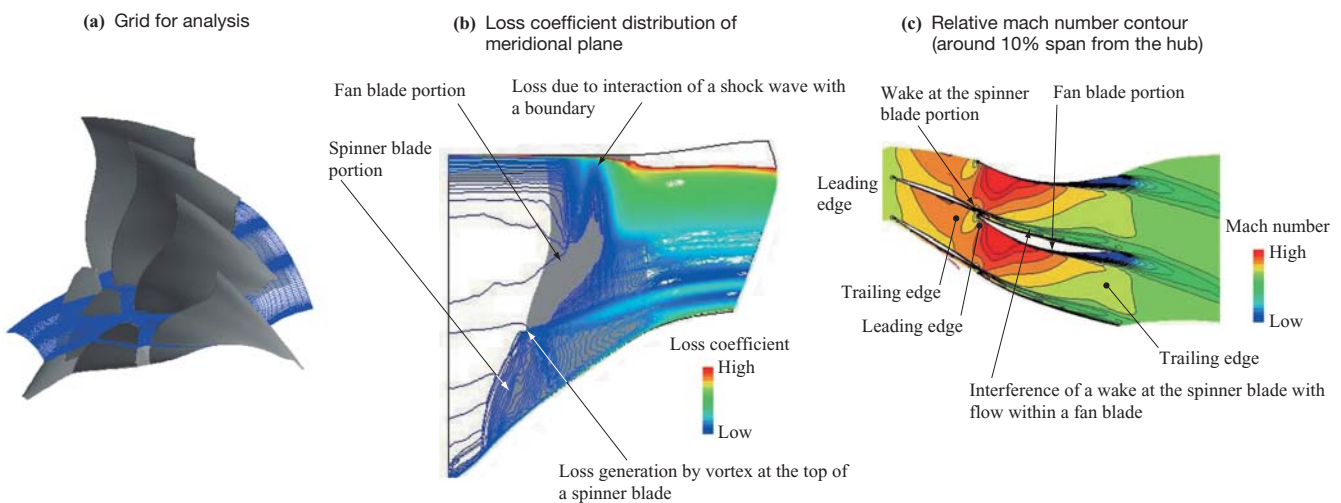

Fig. 4 CFD results of zero hub to tip ratio fan blade (separated blade)

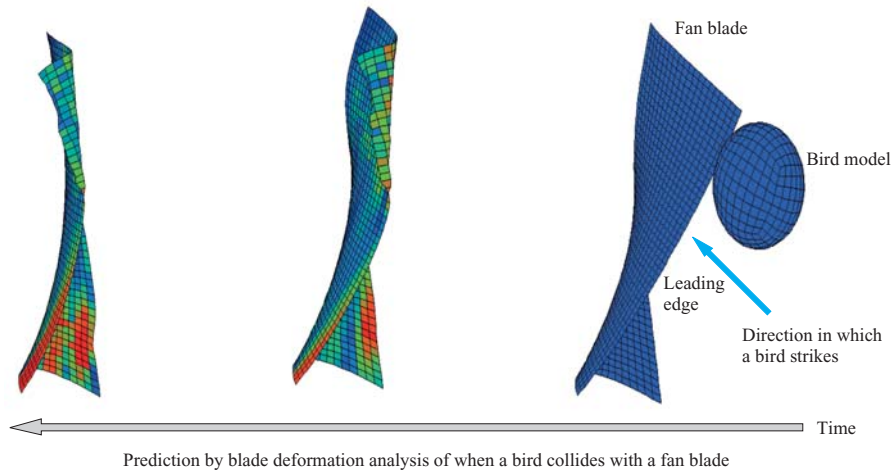

Fig. 5 Simulation of bird-to-single blade impact

sweep and lean excelling in lowering fan noise and improving aero-performance are applied, makes for a structural material as a strut for a fan frame, its strength has been stressed. In the case where a fan blade with higher flow rate and higher pressure ratio at the hub is particularly applied, the sweep and lean configuration aerodynamically excels as well as contributes to the restraint of flow separation from a blade surface and control of the secondary flow due to a high in-flow mach number at the hub of the integrated OGV. **Figure 6** demonstrates one of the results of the CFD analysis over the integrated OGV.

3.3 Fan test rig

Figure 7 demonstrates the fan test rig and instrumentation for an aero-performance test, whereas **Fig. 8** shows the external view of the test rig taken from in front of the fan. The following are all furnished in the test rig: the total pressure and total temperature measuring instrument at the fan inlet, blade exit, and fan exit for the evaluation of aero-performance, a strain gage instrument to obtain the vibration data of the ZH fan

blade; a blade tip clearance measuring instrument, and so forth. The ZH separate blade configuration and ZH single blade configuration are both made into a test rig configuration viable for an aero-performance test by arranging the fan blade part and integrated OGV.

3.4 Results of the aero-performance test

Figure 9 shows the results of the overall performance test (Corrected specific mass flow/Performance map of the fan total pressure ratio) as results of the test for aero-performance with respect to the ZH separate configuration and ZH single blade configuration. **Figure 10** shows the test results of the separate configuration as radial distribution of total pressure ratio at the exit of a fan blade and integrated OGV. A total high pressure ratio was achieved with the target high flow rate as shown in **Fig. 9**, whereas the target pressure ratio of 1.6 and over at the hub for the aerodynamically disadvantageous separate blade configuration was achieved as shown in **Fig. 10**. **Figure 11** demonstrates the flow level and efficiency level thus far achieved. The separate blade configuration achieved high efficiency

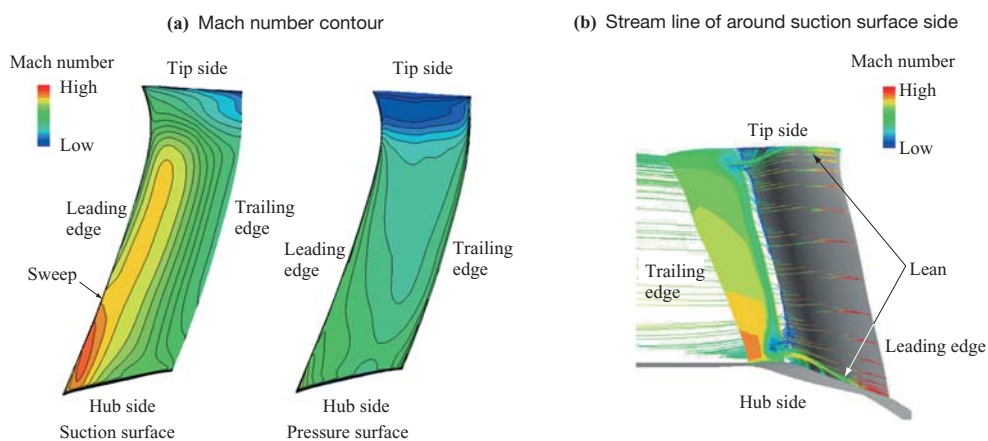

Fig. 6 CFD results of integrated outlet guide vane

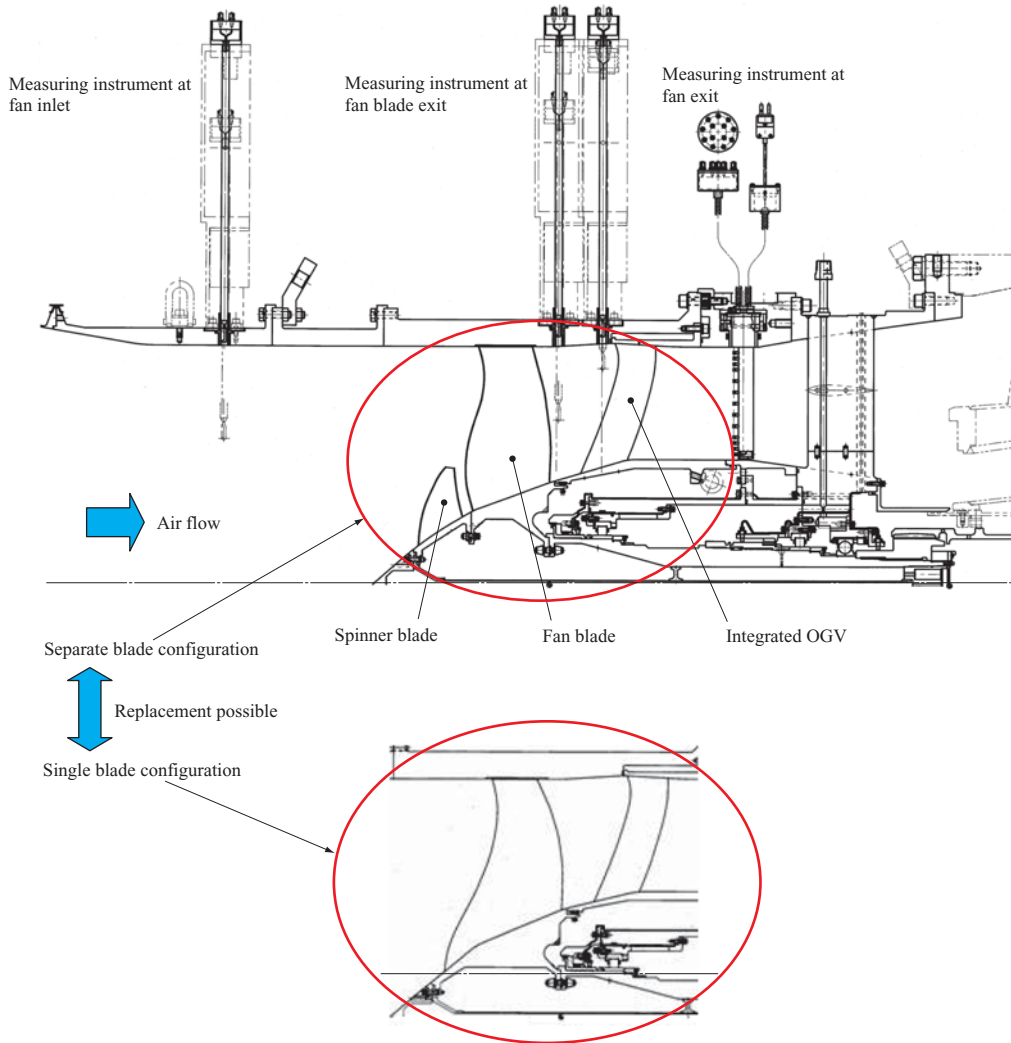
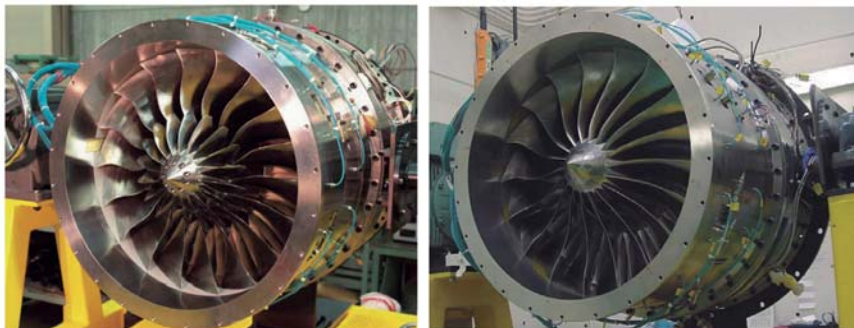

Fig. 7 Cross sectional views of test rig configuration and instrumentation

(a) ZH separate blade configuration

(b) ZH single blade configuration



External view of Fig. 7 taken from upstream

Fig. 8 External view of test rig

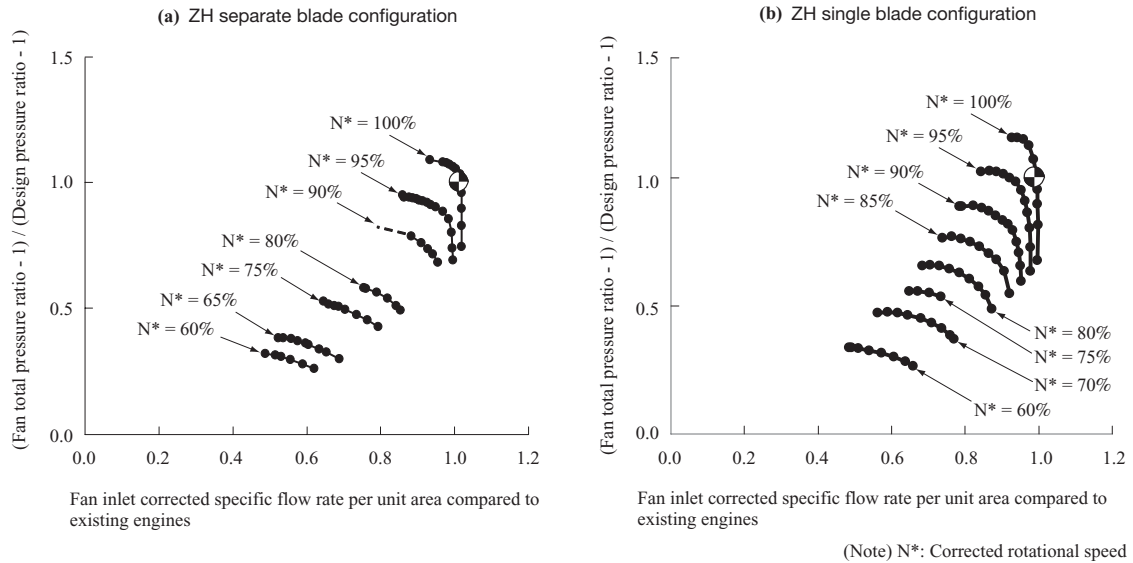

Fig. 9 Test overall performance of zero hub to tip ratio fan

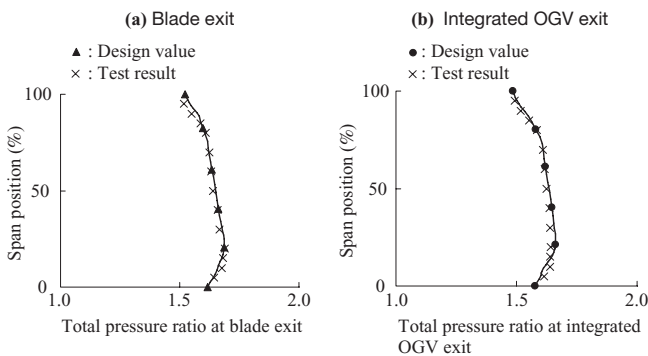

Fig. 10 Tested radial distribution of total pressure ratio (separate configuration)

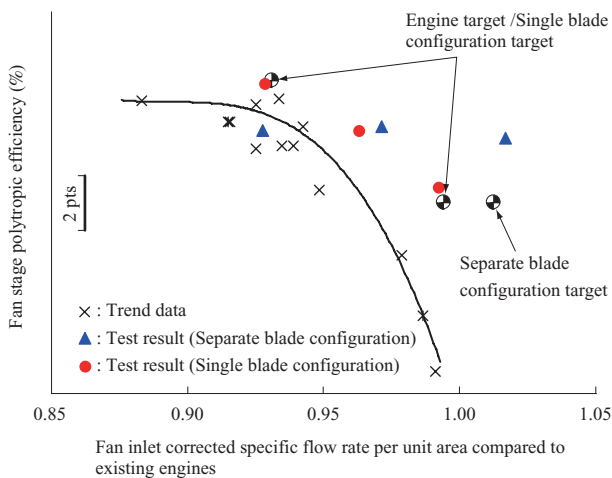

Fig. 11 Test results of specific flow rate and efficiency

under the high mass flow condition, whereas the single blade configuration, high efficiency within the extensive activation range by a trade-off between efficiency under the high rotational speed and high mass flow condition and efficiency under the low rotational speed condition as intended by the design in anticipation of its use with the engine.

4. Conclusion

This document outlines simple, high-performance technology for a fan which has been developed at the ECO engine project.

The ZH fan developed in this research has achieved both an increase in flow rate and high efficiency compared to existing fans and the high pressure ratio at the hub in order to reduce the stage numbers of the compressors or to eliminate low pressure compressors all together; thus, the substantiation of this concept has contributed to the acquisition of the design technology. It is hoped that the acquisition of this cutting-edge technology will largely contribute to a reduction in direct flight costs incurred by the ECO engines.

— Acknowledgments —

This study was conducted as part of the R&D activities of the “Environmentally Compatible Engine for Small Aircraft” project in the Civil Aircraft Fundamental Technology Program implemented by the Ministry of Economy, Trade and Industry, with the support of the New Energy and Industrial Technology Development Organization (NEDO). We would like to extend our sincere appreciation for the cooperation we received in conducting this study from the NEDO and other organizations and people.

We would also like to acknowledge Tetsuji Fujimura, Hiroshi Kuroki, Masahiko Yamamoto, and everyone else

working for the Aviation and Space Administration for a great deal of cooperation throughout the implementation of the research.

REFERENCES

- (1) T. Murooka, S. Goto, I. Mizuta, et al. : Research and development of small class airplane engines, fan and compressor, 47th conference on propulsion and power, B23 Mar. 2007
- (2) O. Funatogawa : Research and Technology Development in Japanese Environmentally Compatible Engine for Small Aircraft Project ISABE-2005-1010 (2005)
- (3) S. Goto and H. Kodama : Design of Advanced Transonic Fan Rotor AJCPP2005 D2-2 (2005)